

# King Drill-2D

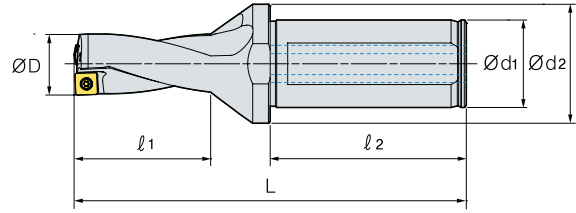
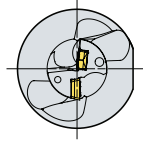

Designation		Stock	ØD	Ød1	Ød2	l1	l2	L	Insert	Screw	Wrench	
<b>K2D</b>	<b>12020-04</b>	▲	12	20	25	27	50	91	SP_T040204-_D XO_T040204-_D	FTNA0204	TW06P	
	<b>12520-04</b>	▲	12.5	20	25	27	50	91		FTNA0204	TW06P	
	<b>13020-04</b>	▲	13	20	25	29	50	93		FTNA0204	TW06P	
	<b>13520-04</b>	▲	13.5	20	25	29	50	93		FTNA0204	TW06P	
	<b>14020-05</b>	▲	14	20	25	31	50	96	SP_T050204-_D XO_T050204-_D	FTNA0204	TW06P	
	<b>14520-05</b>	▲	14.5	20	25	31	50	96		FTNA0204	TW06P	
	<b>15020-05</b>	▲	15	20	25	33	50	99		FTNA0204	TW06P	
	<b>15520-05</b>	▲	15.5	20	25	33	50	99		FTNA0204	TW06P	
	<b>16020-05</b>	▲	16	20	25	35	50	101	SP_T060205-_D XO_T060204-_D	FTNA0204	TW06P	
	<b>16525-06</b>	▲	16.5	25	34	35	56	107		FTKA02206S	TW07P	
	<b>17025-06</b>	▲	17	25	34	37	56	109		FTKA02206S	TW07P	
	<b>17525-06</b>	▲	17.5	25	34	37	56	109		FTKA02206S	TW07P	
	<b>18025-06</b>	▲	18	25	34	39	56	112		FTKA02206S	TW07P	
	<b>18525-06</b>	▲	18.5	25	34	39	56	112		FTKA02206S	TW07P	
	<b>19025-06</b>	▲	19	25	34	41	56	114		FTKA02206S	TW07P	
	<b>19525-06</b>	▲	19.5	25	34	41	56	114		FTKA02206S	TW07P	
	<b>20025-07</b>	▲	20	25	34	43	56	118		SP_T07T208-_D XO_T07T205-_D	FTKA02565	TW07S
	<b>20525-07</b>	▲	20.5	25	34	43	56	118			FTKA02565	TW07S
	<b>21025-07</b>	▲	21	25	34	45	56	120			FTKA02565	TW07S
	<b>21525-07</b>	▲	21.5	25	34	45	56	120			FTKA02565	TW07S
	<b>22025-07</b>	▲	22	25	34	47	56	122			FTKA02565	TW07S
	<b>22525-07</b>	▲	22.5	25	34	47	56	122			FTKA02565	TW07S
	<b>23025-07</b>	▲	23	25	34	49	56	126			FTKA02565	TW07S
	<b>23525-07</b>	▲	23.5	25	34	49	56	126			FTKA02565	TW07S
	<b>24032-09</b>	▲	24	32	44	51	60	133	SP_T090308-_D XO_T090305-_D	FTKA0307	TW09S	
	<b>24532-09</b>	▲	24.5	32	44	51	60	133		FTKA0307	TW09S	
	<b>25032-09</b>	▲	25	32	44	53	60	135		FTKA0307	TW09S	
	<b>25532-09</b>	▲	25.5	32	44	53	60	135		FTKA0307	TW09S	
	<b>26032-09</b>	▲	26	32	44	55	60	137		FTKA0307	TW09S	
	<b>26532-09</b>	▲	26.5	32	44	55	60	137		FTKA0307	TW09S	
	<b>27032-09</b>	▲	27	32	44	57	60	140		FTKA0307	TW09S	
	<b>27532-09</b>	▲	27.5	32	44	57	60	140		FTKA0307	TW09S	
	<b>28032-09</b>	▲	28	32	44	59	60	143		FTKA0307	TW09S	
	<b>28532-09</b>	▲	28.5	32	44	59	60	143		FTKA0307	TW09S	
	<b>29032-09</b>	▲	29	32	44	61	60	145		FTKA0307	TW09S	
	<b>29532-09</b>	▲	29.5	32	44	61	60	145		FTKA0307	TW09S	
	<b>30032-11</b>	▲	30	32	44	63	60	150	SP_T11T308-_D XO_T11T306-_D	FTKA0307	TW15S	
	<b>30532-11</b>	▲	30.5	32	44	63	60	150		FTKA0307	TW15S	
	<b>31032-11</b>	▲	31	32	44	65	60	152		FTKA0307	TW15S	
	<b>31532-11</b>	▲	31.5	32	44	65	60	152		FTKA0307	TW15S	
<b>32032-11</b>	▲	32	32	44	67	60	154	FTKA0307		TW15S		
<b>32532-11</b>	▲	32.5	32	44	67	60	154	FTKA0307		TW15S		
<b>33032-11</b>	▲	33	32	44	69	60	157	FTKA0307		TW15S		
<b>33532-11</b>	▲	33.5	32	44	69	60	157	FTKA0307		TW15S		
<b>34032-11</b>	▲	34	32	44	71	60	159	FTKA0307		TW15S		
<b>34532-11</b>	▲	34.5	32	44	71	60	159	FTKA0307		TW15S		
<b>35032-11</b>	▲	35	32	44	73	60	161	FTKA0307		TW15S		

Applicable inserts: G04

▲ : Stock in Europe ● : Stock in Korea ○ : Order-made item

## King Drill-2D

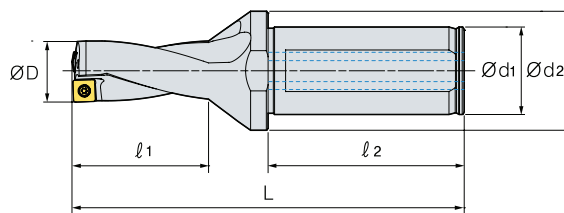
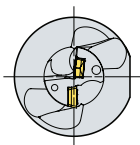

Designation	Stock	ØD	Ød1	Ød2	l1	l2	L	Insert	Screw	Wrench
<b>K2D</b> 35532-11	▲	35.5	32	44	73	60	161	SP_T11T308-D XO_T11T306-D	FTKA0307	TW15S
36040-13	▲	36	40	48	76	70	176	SP_T130410-D XO_T130406-D	FTKA0410	TW15S
36540-13	▲	36.5	40	48	76	70	176		FTKA0410	TW15S
37040-13	▲	37	40	48	78	70	178		FTKA0410	TW15S
37540-13	▲	37.5	40	48	78	70	178		FTKA0410	TW15S
38040-13	▲	38	40	48	80	70	181		FTKA0410	TW15S
38540-13	▲	38.5	40	48	80	70	181		FTKA0410	TW15S
39040-13	▲	39	40	48	82	70	183		FTKA0410	TW15S
39540-13	▲	39.5	40	48	82	70	183		FTKA0410	TW15S
40040-13	▲	40	40	48	84	70	186		FTKA0410	TW15S
40540-13	▲	40.5	40	48	84	70	186		FTKA0410	TW15S
41040-13	▲	41	40	48	86	70	188		FTKA0410	TW15S
41540-13	▲	41.5	40	48	86	70	188		FTKA0410	TW15S
42040-13	▲	42	40	48	88	70	191		FTKA0410	TW15S
42540-13	▲	42.5	40	48	88	70	191		FTKA0410	TW15S
43040-15	▲	43	40	58	91	70	196	SP_T15M510-D XO_T15M508-D	FTNC04511	TW20S
43540-15	▲	43.5	40	58	91	70	196		FTNC04511	TW20S
44040-15	▲	44	40	58	93	70	198		FTNC04511	TW20S
44540-15	▲	44.5	40	58	93	70	198		FTNC04511	TW20S
45040-15	▲	45	40	58	95	70	201		FTNC04511	TW20S
45540-15	▲	45.5	40	58	95	70	201		FTNC04511	TW20S
46040-15	▲	46	40	58	97	70	203		FTNC04511	TW20S
46540-15	▲	46.5	40	58	97	70	203		FTNC04511	TW20S
47040-15	▲	47	40	58	99	70	206		FTNC04511	TW20S
47540-15	▲	47.5	40	58	99	70	206		FTNC04511	TW20S
48040-15	▲	48	40	58	101	70	208		FTNC04511	TW20S
48540-15	▲	48.5	40	58	101	70	208		FTNC04511	TW20S
49040-15	▲	49	40	58	103	70	210		FTNC04511	TW20S
49540-15	▲	49.5	40	58	103	70	210		FTNC04511	TW20S
50040-15	▲	50	40	58	105	70	212	FTNC04511	TW20S	
50540-15	▲	50.5	40	58	105	70	212	FTNC04511	TW20S	
51040-18	▲	51	40	68	108	70	218	SP_T180510-D XO_T180508-D	FTNA0511	TW20-100
51540-18	▲	51.5	40	68	108	70	218		FTNA0511	TW20-100
52040-18	▲	52	40	68	110	70	220		FTNA0511	TW20-100
52540-18	▲	52.5	40	68	110	70	220		FTNA0511	TW20-100
53040-18	▲	53	40	68	112	70	222		FTNA0511	TW20-100
53540-18	▲	53.5	40	68	112	70	222		FTNA0511	TW20-100
54040-18	▲	54	40	68	114	70	224		FTNA0511	TW20-100
54540-18	▲	54.5	40	68	114	70	224		FTNA0511	TW20-100
55040-18	▲	55	40	68	116	70	226		FTNA0511	TW20-100
55540-18	▲	55.5	40	68	116	70	226		FTNA0511	TW20-100
56040-18	▲	56	40	68	118	70	230		FTNA0511	TW20-100
56540-18	▲	56.5	40	68	118	70	230		FTNA0511	TW20-100
57040-18	▲	57	40	68	121	70	233		FTNA0511	TW20-100
57540-18	▲	57.5	40	68	121	70	233		FTNA0511	TW20-100
58040-18	▲	58	40	68	124	70	236	FTNA0511	TW20-100	
58540-18	▲	58.5	40	68	124	70	236	FTNA0511	TW20-100	
59040-18	▲	59	40	68	127	70	239	FTNA0511	TW20-100	

Applicable inserts: G04

▲ : Stock in Europe ● : Stock in Korea ○ : Order-made item

# King Drill-2D

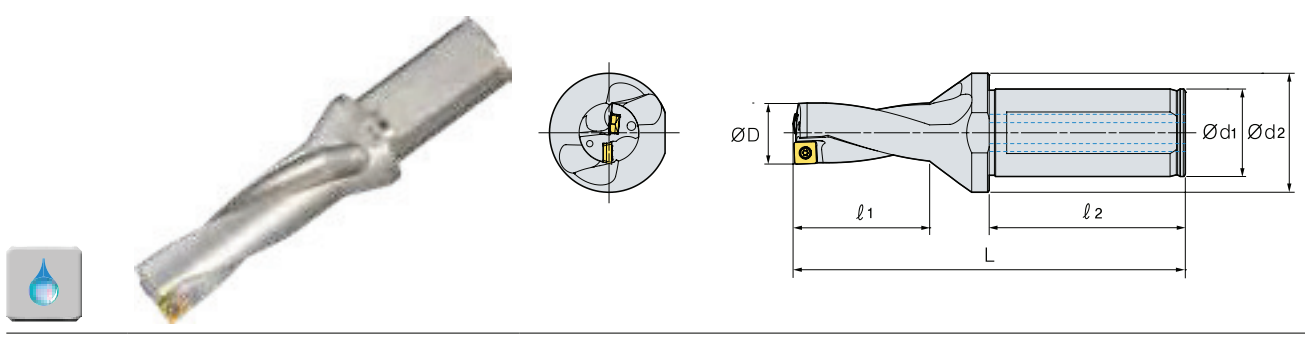

Designation		Stock	ØD	Ød1	Ød2	l1	l2	L	Insert	Screw	Wrench
<b>K2D</b>	<b>59540-18</b>	▲	59.5	40	68	127	70	239	SP_T180510-D X0_T180508-D	FTNA0511	TW20-100
	<b>60040-18</b>	▲	60	40	68	130	70	242		FTNA0511	TW20-100
	<b>60540-18</b>	▲	60.5	40	68	130	70	242		FTNA0511	TW20-100

Applicable inserts: G04

▲ : Stock in Europe ● : Stock in Korea ○ : Order-made item

### King Drill-3D

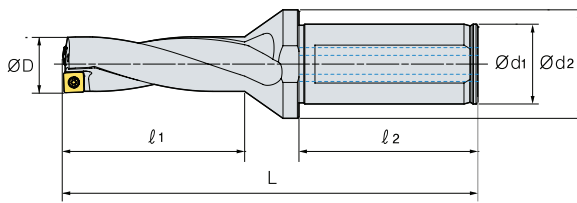
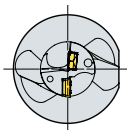

Designation		Stock	ØD	Ød1	Ød2	ℓ1	ℓ2	L	Insert	Screw	Wrench (mm)	
<b>K3D</b>	<b>12020-04*</b>	▲	12	20	25	39	50	103	SP_T040204-_D XO_T040204-_D	FTNA0204	TW06P	
	<b>12220-04</b>	●	12.2	20	25	39	50	103		FTNA0204	TW06P	
	<b>12520-04</b>	▲	12.5	20	25	39	50	103		FTNA0204	TW06P	
	<b>12920-04</b>	●	12.9	20	25	42	50	106		FTNA0204	TW06P	
	<b>13020-04</b>	▲	13	20	25	42	50	106		FTNA0204	TW06P	
	<b>13520-04</b>	▲	13.5	20	25	42	50	106		FTNA0204	TW06P	
	<b>14020-05</b>	▲	14	20	25	45	50	110	SP_T050204-_D XO_T050204-_D	FTNA0204	TW06P	
	<b>14520-05*</b>	▲	14.5	20	25	45	50	110		FTNA0204	TW06P	
	<b>15020-05</b>	▲	15	20	25	48	50	114		FTNA0204	TW06P	
	<b>15520-05*</b>	▲	15.5	20	25	48	50	114		FTNA0204	TW06P	
	<b>16020-05</b>	▲	16	20	25	51	50	117	SP_T060205-_D XO_T060204-_D	FTKA02206S	TW07P	
	<b>16525-06</b>	▲	16.5	25	34	51	56	123		FTKA02206S	TW07P	
	<b>17025-06</b>	▲	17	25	34	54	56	126		FTKA02206S	TW07P	
	<b>17525-06*</b>	▲	17.5	25	34	54	56	126		FTKA02206S	TW07P	
	<b>18025-06</b>	▲	18	25	34	57	56	130		FTKA02206S	TW07P	
	<b>18525-06</b>	▲	18.5	25	34	57	56	130		FTKA02206S	TW07P	
	<b>19025-06</b>	▲	19	25	34	60	56	133		FTKA02206S	TW07P	
	<b>19525-06*</b>	▲	19.5	25	34	60	56	133		FTKA02206S	TW07P	
	<b>20025-07</b>	▲	20	25	34	63	56	138		SP_T07T208-_D XO_T07T205-_D	FTKA02565	TW07S
	<b>20525-07</b>	▲	20.5	25	34	63	56	138			FTKA02565	TW07S
	<b>21025-07*</b>	▲	21	25	34	66	56	141	FTKA02565		TW07S	
	<b>21525-07</b>	▲	21.5	25	34	66	56	141	FTKA02565		TW07S	
	<b>22025-07</b>	▲	22	25	34	69	56	144	FTKA02565		TW07S	
	<b>22525-07</b>	▲	22.5	25	34	69	56	144	FTKA02565		TW07S	
	<b>23025-07</b>	▲		25	34	72	56	149	FTKA02565		TW07S	
	<b>23525-07</b>	▲		23.5	25	34	72	56	149		FTKA02565	TW07S
	<b>24032-09*</b>	▲		24	32	44	75	60	157	SP_T090308-_D XO_T090305-_D	FTKA0307	TW09S
	<b>24532-09</b>	▲		24.5	32	44	75	60	157		FTKA0307	TW09S
	<b>25032-09</b>	▲		25	32	44	78	60	160		FTKA0307	TW09S
	<b>25532-09</b>	▲		25.5	32	44	78	60	160		FTKA0307	TW09S
	<b>26032-09</b>	▲		26	32	44	81	60	163		FTKA0307	TW09S
	<b>26532-09*</b>	▲		26.5	32	44	81	60	163		FTKA0307	TW09S
	<b>27032-09</b>	▲		27	32	44	84	60	167		FTKA0307	TW09S
	<b>27532-09</b>	▲		27.5	32	44	84	60	167		FTKA0307	TW09S
<b>28032-09</b>	▲		28	32	44	87	60	171	FTKA0307		TW09S	
<b>28532-09</b>	▲		28.5	32	44	87	60	171	FTKA0307		TW09S	
<b>29032-09*</b>	▲		29	32	44	90	60	174	FTKA0307	TW09S		
<b>29532-09</b>	▲		29.5	32	44	90	60	174	FTKA0307	TW09S		
<b>30032-11*</b>	▲		30	32	44	93	60	180	SP_T11T308-_D XO_T11T306-_D	FTKA0307	TW15S	
<b>30532-11</b>	▲		30.5	32	44	93	60	180		FTKA0307	TW15S	
<b>31032-11</b>	▲		31	32	44	96	60	183		FTKA0307	TW15S	
<b>31532-11</b>	▲		31.5	32	44	96	60	183		FTKA0307	TW15S	
<b>32032-11</b>	▲		32	32	44	99	60	186		FTKA0307	TW15S	
<b>32532-11</b>	▲		32.5	32	44	99	60	186		FTKA0307	TW15S	
<b>33032-11</b>	▲		33	32	44	102	60	190		FTKA0307	TW15S	
<b>33532-11</b>	▲		33.5	32	44	102	60	190		FTKA0307	TW15S	
<b>34032-11</b>	▲		34	32	44	105	60	193		FTKA0307	TW15S	

Applicable inserts: G04

Items marked with \* can machine a tap foundation hole

▲ : Stock in Europe ● : Stock in Korea ○ : Order-made item

# King Drill-3D

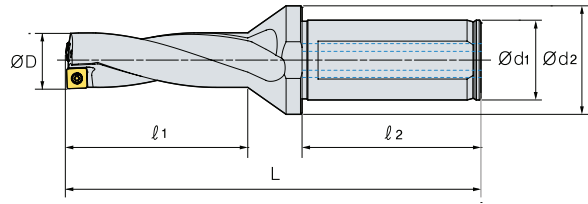
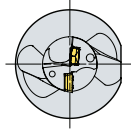

Designation		Stock	ØD	Ød1	Ød2	ℓ1	ℓ2	L	Insert	Screw	Wrench	
<b>K3D</b>	<b>34532-11</b>	▲	34.5	32	44	105	60	193	SP_T11T308-_D XO_T11T306-_D	FTKA0307	TW15S	
	<b>35032-11*</b>	▲	35	32	44	108	60	196		FTKA0307	TW15S	
	<b>35532-11</b>	▲	35.5	32	44	108	60	196		FTKA0307	TW15S	
	<b>36040-13</b>	▲	36	40	48	112	70	212	SP_T130410-_D XO_T130406-_D	FTKA0410	TW15S	
	<b>36540-13</b>	▲	36.5	40	48	112	70	212		FTKA0410	TW15S	
	<b>37040-13</b>	▲	37	40	48	115	70	215		FTKA0410	TW15S	
	<b>37540-13</b>	▲	37.5	40	48	115	70	215		FTKA0410	TW15S	
	<b>38040-13</b>	▲	38	40	48	118	70	219		FTKA0410	TW15S	
	<b>38540-13</b>	▲	38.5	40	48	118	70	219		FTKA0410	TW15S	
	<b>39040-13</b>	▲	39	40	48	121	70	222		FTKA0410	TW15S	
	<b>39540-13</b>	▲	39.5	40	48	121	70	222		FTKA0410	TW15S	
	<b>40040-13</b>	▲	40	40	48	124	70	226		FTKA0410	TW15S	
	<b>40540-13</b>	▲	40.5	40	48	124	70	226		FTKA0410	TW15S	
	<b>41040-13</b>	▲	41	40	48	127	70	229		FTKA0410	TW15S	
	<b>41540-13</b>	▲	41.5	40	48	127	70	229		FTKA0410	TW15S	
	<b>42040-13</b>	▲	42	40	48	130	70	233		FTKA0410	TW15S	
	<b>42540-13</b>	▲	42.5	40	48	130	70	233		FTKA0410	TW15S	
	<b>43040-15</b>	▲	43	40	58	134	70	239		SP_T15M510-_D XO_T15M508-_D	FTNC04511	TW20S
	<b>43540-15</b>	▲	43.5	40	58	134	70	239			FTNC04511	TW20S
	<b>44040-15</b>	▲	44	40	58	137	70	242			FTNC04511	TW20S
	<b>44540-15</b>	▲	44.5	40	58	137	70	242	FTNC04511		TW20S	
	<b>45040-15</b>	▲	45	40	58	140	70	246	FTNC04511		TW20S	
	<b>45540-15</b>	▲	45.5	40	58	140	70	246	FTNC04511		TW20S	
	<b>46040-15</b>	▲	46	40	58	143	70	249	FTNC04511		TW20S	
	<b>46540-15</b>	▲	46.5	40	58	143	70	249	FTNC04511		TW20S	
	<b>47040-15</b>	▲	47	40	58	146	70	253	FTNC04511		TW20S	
	<b>47540-15</b>	▲	47.5	40	58	146	70	253	FTNC04511		TW20S	
	<b>48040-15</b>	▲	48	40	58	149	70	256	FTNC04511		TW20S	
	<b>48540-15</b>	▲	48.5	40	58	149	70	256	FTNC04511		TW20S	
	<b>49040-15</b>	▲	49	40	58	152	70	259	FTNC04511		TW20S	
	<b>49540-15</b>	▲	49.5	40	58	152	70	259	FTNC04511		TW20S	
	<b>50040-15</b>	▲	50	40	58	155	70	262	FTNC04511		TW20S	
	<b>50540-15</b>	▲	50.5	40	58	155	70	262	FTNC04511		TW20S	
	<b>51040-18</b>	▲	51	40	68	159	70	269	SP_T180510-_D XO_T180508-_D		FTNA0511	TW20-100
	<b>51540-18</b>	▲	51.5	40	68	159	70	269		FTNA0511	TW20-100	
	<b>52040-18</b>	▲	52	40	68	162	70	272		FTNA0511	TW20-100	
	<b>52540-18</b>	▲	52.5	40	68	162	70	272		FTNA0511	TW20-100	
	<b>53040-18</b>	▲	53	40	68	165	70	275		FTNA0511	TW20-100	
	<b>53540-18</b>	▲	53.5	40	68	165	70	275		FTNA0511	TW20-100	
	<b>54040-18</b>	▲	54	40	68	168	70	278		FTNA0511	TW20-100	
	<b>54540-18</b>	▲	54.5	40	68	168	70	278		FTNA0511	TW20-100	
	<b>55040-18</b>	▲	55	40	68	171	70	281		FTNA0511	TW20-100	
	<b>55540-18</b>	▲	55.5	40	68	171	70	281		FTNA0511	TW20-100	
	<b>56040-18</b>	▲	56	40	68	174	70	286		FTNA0511	TW20-100	
	<b>56540-18</b>	▲	56.5	40	68	174	70	286		FTNA0511	TW20-100	
	<b>57040-18</b>	▲	57	40	68	178	70	290		FTNA0511	TW20-100	
	<b>57540-18</b>	▲	57.5	40	68	178	70	290	FTNA0511	TW20-100		
	<b>58040-18</b>	▲	58	40	68	182	70	294	FTNA0511	TW20-100		

Applicable inserts: G04

Items marked with \* can machine a tap foundation hole

▲ : Stock in Europe ● : Stock in Korea ○ : Order-made item

### King Drill-3D

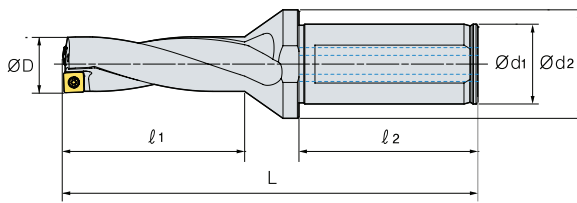
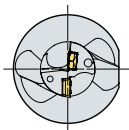

Designation		Stock	ØD	Ød1	Ød2	ℓ1	ℓ2	L	Insert	Screw	Wrench	(mm)
<b>K3D</b>	<b>58540-18</b>	▲	58.5	40	68	182	70	294	SP_T180510-_D XO_T180508-_D	FTNA0511	TW20-100	
	<b>59040-18</b>	▲	59	40	68	186	70	298		FTNA0511	TW20-100	
	<b>59540-18</b>	▲	59.5	40	68	186	70	298		FTNA0511	TW20-100	
	<b>60040-18</b>	▲	60	40	68	190	70	302		FTNA0511	TW20-100	
	<b>60540-18</b>	▲	60.5	40	68	190	70	302		FTNA0511	TW20-100	

Applicable inserts: G04

Items marked with \* can machine a tap foundation hole

▲ : Stock in Europe ● : Stock in Korea ○ : Order-made item

# King Drill-4D

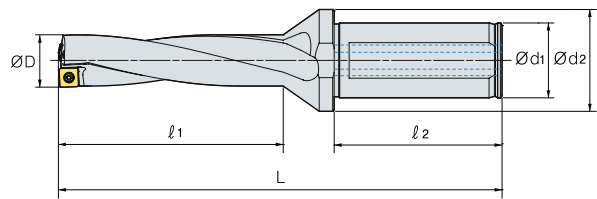
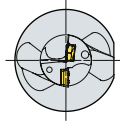

Designation		Stock	ØD	Ød1	Ød2	ℓ1	ℓ2	L	Insert	Screw	Wrench	
<b>K4D</b>	<b>12020-04</b>	▲	12	20	25	51	50	115	SP_T040204- D XO_T040204- D	FTNA0204	TW06P	
	<b>12520-04</b>	▲	12.5	20	25	51	50	115		FTNA0204	TW06P	
	<b>13020-04</b>	▲	13	20	25	55	50	119		FTNA0204	TW06P	
	<b>13520-04</b>	▲	13.5	20	25	55	50	119		FTNA0204	TW06P	
	<b>14020-05</b>	▲	14	20	25	59	50	124	SP_T050204- D XO_T050204- D	FTNA0204	TW06P	
	<b>14520-05</b>	▲	14.5	20	25	59	50	124		FTNA0204	TW06P	
	<b>15020-05</b>	▲	15	20	25	63	50	129		FTNA0204	TW06P	
	<b>15520-05</b>	▲	15.5	20	25	63	50	129		FTNA0204	TW06P	
	<b>16020-05</b>	▲	16	20	25	67	50	133	SP_T060205- D XO_T060204- D	FTNA0204	TW06P	
	<b>16525-06</b>	▲	16.5	25	34	67	56	139		FTKA02206S	TW07P	
	<b>17025-06</b>	▲	17	25	34	71	56	143		FTKA02206S	TW07P	
	<b>17525-06</b>	▲	17.5	25	34	71	56	143		FTKA02206S	TW07P	
	<b>18025-06</b>	▲	18	25	34	75	56	148		FTKA02206S	TW07P	
	<b>18525-06</b>	▲	18.5	25	34	75	56	148		FTKA02206S	TW07P	
	<b>19025-06</b>	▲	19	25	34	79	56	152		FTKA02206S	TW07P	
	<b>19525-06</b>	▲	19.5	25	34	79	56	152		FTKA02206S	TW07P	
	<b>20025-07</b>	▲	20	25	34	83	56	158		SP_T07T208- D XO_T07T205- D	FTKA02565	TW07S
	<b>20525-07</b>	▲	20.5	25	34	83	56	158			FTKA02565	TW07S
	<b>21025-07</b>	▲	21	25	34	87	56	162			FTKA02565	TW07S
	<b>21525-07</b>	▲	21.5	25	34	87	56	162			FTKA02565	TW07S
	<b>22025-07</b>	▲	22	25	34	91	56	166	FTKA02565		TW07S	
	<b>22525-07</b>	▲	22.5	25	34	91	56	166	FTKA02565		TW07S	
	<b>23025-07</b>	▲	23	25	34	95	56	172	FTKA02565		TW07S	
	<b>23525-07</b>	▲	23.5	25	34	95	56	172	FTKA02565		TW07S	
	<b>24032-09</b>	▲	24	32	44	99	60	181	SP_T090308- D XO_T090305- D	FTKA0307	TW09S	
	<b>24532-09</b>	▲	24.5	32	44	99	60	181		FTKA0307	TW09S	
	<b>25032-09</b>	▲	25	32	44	103	60	185		FTKA0307	TW09S	
	<b>25532-09</b>	▲	25.5	32	44	103	60	185		FTKA0307	TW09S	
	<b>26032-09</b>	▲	26	32	44	107	60	189		FTKA0307	TW09S	
	<b>26532-09</b>	▲	26.5	32	44	107	60	189		FTKA0307	TW09S	
	<b>27032-09</b>	▲	27	32	44	111	60	194		FTKA0307	TW09S	
	<b>27532-09</b>	▲	27.5	32	44	111	60	194		FTKA0307	TW09S	
	<b>28032-09</b>	▲	28	32	44	115	60	199		FTKA0307	TW09S	
	<b>28532-09</b>	▲	28.5	32	44	115	60	199		FTKA0307	TW09S	
	<b>29032-09</b>	▲	29	32	44	119	60	203		FTKA0307	TW09S	
	<b>29532-09</b>	▲	29.5	32	44	119	60	203		FTKA0307	TW09S	
	<b>30032-11</b>	▲	30	32	44	123	60	210	SP_T11T308- D XO_T11T306- D	FTKA0307	TW15S	
	<b>30532-11</b>	▲	30.5	32	44	123	60	210		FTKA0307	TW15S	
	<b>31032-11</b>	▲	31	32	44	127	60	214		FTKA0307	TW15S	
	<b>31532-11</b>	▲	31.5	32	44	127	60	214		FTKA0307	TW15S	
<b>32032-11</b>	▲	32	32	44	131	60	218	FTKA0307		TW15S		
<b>32532-11</b>	▲	32.5	32	44	131	60	218	FTKA0307		TW15S		
<b>33032-11</b>	▲	33	32	44	135	60	223	FTKA0307		TW15S		
<b>33532-11</b>	▲	33.5	32	44	135	60	223	FTKA0307		TW15S		
<b>34032-11</b>	▲	34	32	44	139	60	227	FTKA0307		TW15S		
<b>34532-11</b>	▲	34.5	32	44	139	60	227	FTKA0307		TW15S		
<b>35032-11</b>	▲	35	32	44	143	60	231	FTKA0307		TW15S		

Applicable inserts: G04

▲ : Stock in Europe ● : Stock in Korea ○ : Order-made item

### King Drill-4D

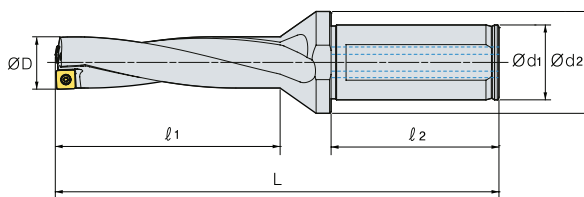
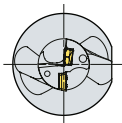

Designation	Stock	ØD	Ød1	Ød2	ℓ1	ℓ2	L	Insert	Screw	Wrench
<b>K4D</b> 35532-11	▲	35.5	32	44	143	60	231	SP_T11T308-D XO_T11T306-D	FTKA0307	TW15S
36040-13	▲	36	40	48	148	70	248	SP_T130410-D XO_T130406-D	FTKA0410	TW15S
36540-13	▲	36.5	40	48	148	70	248		FTKA0410	TW15S
37040-13	▲	37	40	48	152	70	252		FTKA0410	TW15S
37540-13	▲	37.5	40	48	152	70	252		FTKA0410	TW15S
38040-13	▲	38	40	48	156	70	257		FTKA0410	TW15S
38540-13	▲	38.5	40	48	156	70	257		FTKA0410	TW15S
39040-13	▲	39	40	48	160	70	261		FTKA0410	TW15S
39540-13	▲	39.5	40	48	160	70	261		FTKA0410	TW15S
40040-13	▲	40	40	48	164	70	266		FTKA0410	TW15S
40540-13	▲	40.5	40	48	164	70	266		FTKA0410	TW15S
41040-13	▲	41	40	48	168	70	270		FTKA0410	TW15S
41540-13	▲	41.5	40	48	168	70	270		FTKA0410	TW15S
42040-13	▲	42	40	48	172	70	275		FTKA0410	TW15S
42540-13	▲	42.5	40	48	172	70	275		FTKA0410	TW15S
43040-15	▲	43	40	58	177	70	282	SP_T15M510-D XO_T15M508-D	FTNC04511	TW20S
43540-15	▲	43.5	40	58	177	70	282		FTNC04511	TW20S
44040-15	▲	44	40	58	181	70	286		FTNC04511	TW20S
44540-15	▲	44.5	40	58	181	70	286		FTNC04511	TW20S
45040-15	▲	45	40	58	185	70	291		FTNC04511	TW20S
45540-15	▲	45.5	40	58	185	70	291		FTNC04511	TW20S
46040-15	▲	46	40	58	189	70	295		FTNC04511	TW20S
46540-15	▲	46.5	40	58	189	70	295		FTNC04511	TW20S
47040-15	▲	47	40	58	193	70	300		FTNC04511	TW20S
47540-15	▲	47.5	40	58	193	70	300		FTNC04511	TW20S
48040-15	▲	48	40	58	197	70	304		FTNC04511	TW20S
48540-15	▲	48.5	40	58	197	70	304		FTNC04511	TW20S
49040-15	▲	49	40	58	201	70	308		FTNC04511	TW20S
49540-15	▲	49.5	40	58	201	70	308		FTNC04511	TW20S
50040-15	▲	50	40	58	205	70	312		FTNC04511	TW20S
50540-15	▲	50.5	40	58	205	70	312		FTNC04511	TW20S
51040-18	▲	51	40	68	210	70	320	SP_T180510-D XO_T180508-D	FTNA0511	TW20-100
51540-18	▲	51.5	40	68	210	70	320		FTNA0511	TW20-100
52040-18	▲	52	40	68	214	70	324		FTNA0511	TW20-100
52540-18	▲	52.5	40	68	214	70	324		FTNA0511	TW20-100
53040-18	▲	53	40	68	218	70	328		FTNA0511	TW20-100
53540-18	▲	53.5	40	68	218	70	328		FTNA0511	TW20-100
54040-18	▲	54	40	68	222	70	332		FTNA0511	TW20-100
54540-18	▲	54.5	40	68	222	70	332		FTNA0511	TW20-100
55040-18	▲	55	40	68	226	70	336		FTNA0511	TW20-100
55540-18	▲	55.5	40	68	226	70	336		FTNA0511	TW20-100
56040-18	▲	56	40	68	230	70	342		FTNA0511	TW20-100
56540-18	▲	56.5	40	68	230	70	342		FTNA0511	TW20-100
57040-18	▲	57	40	68	235	70	347		FTNA0511	TW20-100
57540-18	▲	57.5	40	68	235	70	347		FTNA0511	TW20-100
58040-18	▲	58	40	68	240	70	352		FTNA0511	TW20-100
58540-18	▲	58.5	40	68	240	70	352		FTNA0511	TW20-100
59040-18	▲	59	40	68	245	70	357		FTNA0511	TW20-100

Applicable inserts: G04

▲ : Stock in Europe ● : Stock in Korea ○ : Order-made item



# King Drill-4D

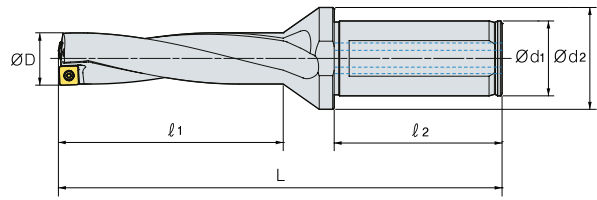
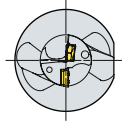

Designation		Stock	ØD	Ød1	Ød2	l1	l2	L	Insert	Screw	Wrench
<b>K4D</b>	<b>59540-18</b>	▲	59.5	40	68	245	70	357	SP_T180510-D X0_T180508-D	FTNA0511	TW20-100
	<b>60040-18</b>	▲	60	40	68	250	70	362		FTNA0511	TW20-100
	<b>60540-18</b>	▲	60.5	40	68	250	70	362		FTNA0511	TW20-100

Applicable inserts: G04

▲ : Stock in Europe ● : Stock in Korea ○ : Order-made item

### King Drill-5D

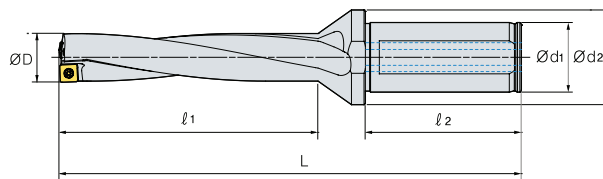
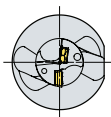

Designation		Stock	ØD	Ød1	Ød2	l1	l2	L	Insert	Screw	Wrench
<b>K5D</b>	<b>12020-04</b>	▲	12	20	25	63	50	127	SP_T040204-D XO_T040204-D	FTNA0204	TW06P
	<b>12520-04</b>	▲	12.5	20	25	63	50	127		FTNA0204	TW06P
	<b>13020-04</b>	▲	13	20	25	68	50	132		FTNA0204	TW06P
	<b>13520-04</b>	▲	13.5	20	25	68	50	132		FTNA0204	TW06P
	<b>14020-05</b>	▲	14	20	25	73	50	138	SP_T050204-D XO_T050204-D	FTNA0204	TW06P
	<b>14520-05</b>	▲	14.5	20	25	73	50	138		FTNA0204	TW06P
	<b>15020-05</b>	▲	15	20	25	78	50	144		FTNA0204	TW06P
	<b>15520-05</b>	▲	15.5	20	25	78	50	144		FTNA0204	TW06P
	<b>16020-05</b>	▲	16	20	25	83	50	149	FTNA0204	TW06P	
	<b>16525-06</b>	▲	16.5	25	34	83	56	155	SP_T060205-D XO_T060204-D	FTKA02206S	TW07P
	<b>17025-06</b>	▲	17	25	34	88	56	160		FTKA02206S	TW07P
	<b>17525-06</b>	▲	17.5	25	34	88	56	160		FTKA02206S	TW07P
	<b>18025-06</b>	▲	18	25	34	93	56	166		FTKA02206S	TW07P
	<b>18525-06</b>	▲	18.5	25	34	93	56	166	FTKA02206S	TW07P	
	<b>19025-06</b>	▲	19	25	34	98	56	171	FTKA02206S	TW07P	
	<b>19525-06</b>	▲	19.5	25	34	98	56	171	FTKA02206S	TW07P	
	<b>20025-07</b>	▲	20	25	34	103	56	178	SP_T07T208-D XO_T07T205-D	FTKA02565	TW07S
	<b>20525-07</b>	▲	20.5	25	34	103	56	178		FTKA02565	TW07S
	<b>21025-07</b>	▲	21	25	34	108	56	183		FTKA02565	TW07S
	<b>21525-07</b>	▲	21.5	25	34	108	56	183		FTKA02565	TW07S
	<b>22025-07</b>	▲	22	25	34	113	56	188		FTKA02565	TW07S
	<b>22525-07</b>	▲	22.5	25	34	113	56	188		FTKA02565	TW07S
	<b>23025-07</b>	▲	23	25	34	118	56	195		FTKA02565	TW07S
	<b>23525-07</b>	▲	23.5	25	34	118	56	195		FTKA02565	TW07S
	<b>24032-09</b>	▲	24	32	44	123	60	205	SP_T090305-D XO_T090305-D	FTKA0307	TW09S
	<b>24532-09</b>	▲	24.5	32	44	123	60	205		FTKA0307	TW09S
	<b>25032-09</b>	▲	25	32	44	128	60	210		FTKA0307	TW09S
	<b>25532-09</b>	▲	25.5	32	44	128	60	210		FTKA0307	TW09S
	<b>26032-09</b>	▲	26	32	44	133	60	215		FTKA0307	TW09S
	<b>26532-09</b>	▲	26.5	32	44	133	60	215		FTKA0307	TW09S
	<b>27032-09</b>	▲	27	32	44	138	60	221		FTKA0307	TW09S
	<b>27532-09</b>	▲	27.5	32	44	138	60	221		FTKA0307	TW09S
	<b>28032-09</b>	▲	28	32	44	143	60	227		FTKA0307	TW09S
	<b>28532-09</b>	▲	28.5	32	44	143	60	227		FTKA0307	TW09S
	<b>29032-09</b>	▲	29	32	44	148	60	232		FTKA0307	TW09S
	<b>29532-09</b>	▲	29.5	32	44	148	60	232		FTKA0307	TW09S
	<b>30032-11</b>	▲	30	32	44	153	60	240	SP_T11T308-D XO_T11T306-D	FTKA0307	TW15S
	<b>30532-11</b>	▲	30.5	32	44	153	60	240		FTKA0307	TW15S
	<b>31032-11</b>	▲	31	32	44	158	60	245		FTKA0307	TW15S
	<b>31532-11</b>	▲	31.5	32	44	158	60	245		FTKA0307	TW15S
<b>32032-11</b>	▲	32	32	44	163	60	250	FTKA0307		TW15S	
<b>32532-11</b>	▲	32.5	32	44	163	60	250	FTKA0307		TW15S	
<b>33032-11</b>	▲	33	32	44	168	60	256	FTKA0307		TW15S	
<b>33532-11</b>	▲	33.5	32	44	168	60	256	FTKA0307		TW15S	
<b>34032-11</b>	▲	34	32	44	173	60	261	FTKA0307		TW15S	
<b>34532-11</b>	▲	34.5	32	44	173	60	261	FTKA0307		TW15S	
<b>35032-11</b>	▲	35	32	44	178	60	266	FTKA0307		TW15S	

Applicable inserts: G04

▲ : Stock in Europe ● : Stock in Korea ○ : Order-made item

# King Drill-5D

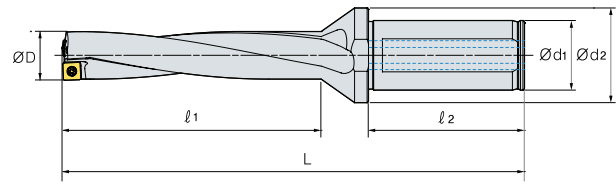
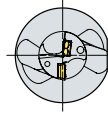

Designation		Stock	ØD	Ød1	Ød2	l1	l2	L	Insert	Screw	Wrench
<b>K5D</b>	<b>35532-11</b>	▲	35.5	32	44	178	60	266	SP_T11T308-_D XO_T11T306-_D	FTKA0307	TW15S
	<b>36040-13</b>	▲	36	40	48	184	70	284	SP_T130410-_D XO_T130406-_D	FTKA0410	TW15S
	<b>36540-13</b>	▲	36.5	40	48	184	70	284	FTKA0410	FTKA0410	TW15S
	<b>37040-13</b>	▲	37	40	48	189	70	289	FTKA0410	FTKA0410	TW15S
	<b>37540-13</b>	▲	37.5	40	48	189	70	289	FTKA0410	FTKA0410	TW15S
	<b>38040-13</b>	▲	38	40	48	194	70	295	FTKA0410	FTKA0410	TW15S
	<b>38540-13</b>	▲	38.5	40	48	194	70	295	FTKA0410	FTKA0410	TW15S
	<b>39040-13</b>	▲	39	40	48	199	70	300	FTKA0410	FTKA0410	TW15S
	<b>39540-13</b>	▲	39.5	40	48	199	70	300	FTKA0410	FTKA0410	TW15S
	<b>40040-13</b>	▲	40	40	48	204	70	306	FTKA0410	FTKA0410	TW15S
	<b>40540-13</b>	▲	40.5	40	48	204	70	306	FTKA0410	FTKA0410	TW15S
	<b>41040-13</b>	▲	41	40	48	209	70	311	FTKA0410	FTKA0410	TW15S
	<b>41540-13</b>	▲	41.5	40	48	209	70	311	FTKA0410	FTKA0410	TW15S
	<b>42040-13</b>	▲	42	40	48	214	70	317	FTKA0410	FTKA0410	TW15S
	<b>42540-13</b>	▲	42.5	40	48	214	70	317	FTKA0410	FTKA0410	TW15S
	<b>43040-15</b>	▲	43	40	58	220	70	325	SP_T15M510-_D XO_T15M508-_D	FTNC04511	TW20S
	<b>43540-15</b>	▲	43.5	40	58	221	70	326	FTNC04511	FTNC04511	TW20S
	<b>44040-15</b>	▲	44	40	58	225	70	330	FTNC04511	FTNC04511	TW20S
	<b>44540-15</b>	▲	44.5	40	58	225	70	330	FTNC04511	FTNC04511	TW20S
	<b>45040-15</b>	▲	45	40	58	230	70	336	FTNC04511	FTNC04511	TW20S
	<b>45540-15</b>	▲	45.5	40	58	230	70	336	FTNC04511	FTNC04511	TW20S
	<b>46040-15</b>	▲	46	40	58	235	70	341	FTNC04511	FTNC04511	TW20S
	<b>46540-15</b>	▲	46.5	40	58	235	70	341	FTNC04511	FTNC04511	TW20S
	<b>47040-15</b>	▲	47	40	58	240	70	347	FTNC04511	FTNC04511	TW20S
	<b>47540-15</b>	▲	47.5	40	58	240	70	347	FTNC04511	FTNC04511	TW20S
	<b>48040-15</b>	▲	48	40	58	245	70	352	FTNC04511	FTNC04511	TW20S
	<b>48540-15</b>	▲	48.5	40	58	245	70	352	FTNC04511	FTNC04511	TW20S
	<b>49040-15</b>	▲	49	40	58	250	70	357	FTNC04511	FTNC04511	TW20S
	<b>49540-15</b>	▲	49.5	40	58	250	70	357	FTNC04511	FTNC04511	TW20S
	<b>50040-15</b>	▲	50	40	58	255	70	362	FTNC04511	FTNC04511	TW20S
	<b>50540-15</b>	▲	50.5	40	58	255	70	362	FTNC04511	FTNC04511	TW20S
	<b>51040-18</b>	▲	51	40	68	261	70	371	SP_T180510-_D XO_T180508-_D	FTNA0511	TW20-100
	<b>51540-18</b>	▲	51.5	40	68	261	70	371	FTNA0511	FTNA0511	TW20-100
	<b>52040-18</b>	▲	52	40	68	266	70	376	FTNA0511	FTNA0511	TW20-100
	<b>52540-18</b>	▲	52.5	40	68	266	70	376	FTNA0511	FTNA0511	TW20-100
	<b>53040-18</b>	▲	53	40	68	271	70	381	FTNA0511	FTNA0511	TW20-100
	<b>53540-18</b>	▲	53.5	40	68	271	70	381	FTNA0511	FTNA0511	TW20-100
	<b>54040-18</b>	▲	54	40	68	276	70	386	FTNA0511	FTNA0511	TW20-100
	<b>54540-18</b>	▲	54.5	40	68	276	70	386	FTNA0511	FTNA0511	TW20-100
	<b>55040-18</b>	▲	55	40	68	281	70	391	FTNA0511	FTNA0511	TW20-100
	<b>55540-18</b>	▲	55.5	40	68	281	70	391	FTNA0511	FTNA0511	TW20-100
	<b>56040-18</b>	▲	56	40	68	286	70	398	FTNA0511	FTNA0511	TW20-100
	<b>56540-18</b>	▲	56.5	40	68	286	70	398	FTNA0511	FTNA0511	TW20-100
	<b>57040-18</b>	▲	57	40	68	292	70	404	FTNA0511	FTNA0511	TW20-100
	<b>57540-18</b>	▲	57.5	40	68	292	70	404	FTNA0511	FTNA0511	TW20-100
	<b>58040-18</b>	▲	58	40	68	298	70	410	FTNA0511	FTNA0511	TW20-100
	<b>58540-18</b>	▲	58.5	40	68	298	70	410	FTNA0511	FTNA0511	TW20-100
	<b>59040-18</b>	▲	59	40	68	304	70	416	FTNA0511	FTNA0511	TW20-100

Applicable inserts: G04

▲ : Stock in Europe ● : Stock in Korea ○ : Order-made item

### King Drill-5D

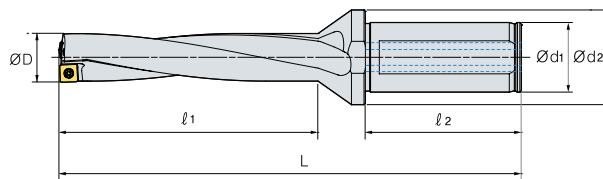
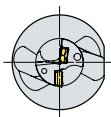

Designation		Stock	ØD	Ød1	Ød2	l1	l2	L	Insert	Screw	Wrench	(mm)
<b>K5D</b>	<b>59540-18</b>	▲	59.5	40	68	304	70	416	SP_T180510-D XO_T180508-D	FTNA0511	TW20-100	
	<b>60040-18</b>	▲	60	40	68	310	70	422		FTNA0511	TW20-100	
	<b>60540-18</b>	▲	60.5	40	68	310	70	422		FTNA0511	TW20-100	

Applicable inserts: G04

▲ : Stock in Europe ● : Stock in Korea ○ : Order-made item